



Instrumente der
Mikrochirurgie

*Instruments of
Micro Surgery*

Mikrochirurgie
Micro Surgery



Sehr geehrte Kunden,

mit diesem Katalog erhalten Sie einen umfassenden Überblick über unser Instrumentarium der Mikrochirurgie. Dabei bieten wir Ihnen selbstverständlich die hohe Qualität in Material und Verarbeitung die Sie von unseren Produkten kennen. Alle Produkte sind „*Made in Germany*“.

Hervorheben möchten wir unsere *atraumatischen Nadel-Faden-Kombinationen* mit gewebeschonenden Durchstich- und Gleiteigenschaften.

Wir können jederzeit flexibel Ihre individuellen Produktwünsche berücksichtigen, insbesondere hinsichtlich Nahtmaterial und Mikroinstrumenten.

Dipl. Ing. Eduard Steidle
Geschäftsführer / General Manager

Dear Customers,







with this catalogue we would like to give you a comprehensive insight into our modern instruments of microsurgery. As a matter of course we provide you with the high quality of material and workmanship which you are accustomed with from our products. All products are „*Made in Germany*“.

We would like to point out our atraumatic Needle Suture-Combinations, showing tissue-conserving cutting and gliding properties. If so requested, we are able to consider your individual demands, especially concerning suture and micro instruments.



Inhalt

Contents

	Mikronahtmaterial <i>Micro Sutures</i>	4 - 9
	Pinzetten mit Rundgriff Pinzetten mit Rundgriff und Gegengewicht <i>Forceps with Round Handle</i> <i>Forceps with Round Handle and Counter Balance</i>	10 - 13
	Pinzetten mit Flachgriff <i>Forceps with Flat Handle</i>	14 - 15
	Nadelhalter gerade und gebogen mit Rundgriff <i>Needle Holders straight and curved with Round Handle</i>	16 - 19
	Nadelhalter gerade und gebogen mit Flachgriff <i>Needle Holders straight and curved with Flat Handle</i>	20 - 21
	Scheren gerade und gebogen mit Rundgriff <i>Scissors straight and curved with Round Handle</i>	22 - 23
	Scheren gerade, gebogen und abgewinkelt mit Flachgriff <i>Scissors straight, curved and angled with Flat Handle</i>	24 - 25
	Gefäßklemmen und Pinzetten <i>Vascular Clamps and Forceps</i>	26 - 29
	Sterilisations-Kassetten <i>Sterilization Cassettes</i>	30 - 31

Mikronahtmaterial

Micro Sutures

Die Herstellung unserer Mikronadeln erfolgt aus kaltgeformtem AISI 300 Stahl. Diese bieten wir in unterschiedlichen Formen, Spitzen, Längen und Durchmessern an. Alle vier Mikronadeltypen werden mit schwarzem Nylonfaden, Polyamid 6.6 monofil angeboten. Das Standardmaterial Nylon besitzt eine glatte Oberfläche und damit besonders gute Gleiteigenschaften im Gewebe.

Our micro needles are cold formed of high quality stainless AISI 300 series steel. We offer them in different forms, tips, lengths and diameters. All four types of micro needles are offered with black nylon thread, polyamide 6.6 monofilament. The standard material nylon has a smooth surface for easy passage through tissue.

Nadelgeometrie

Needle Geometry

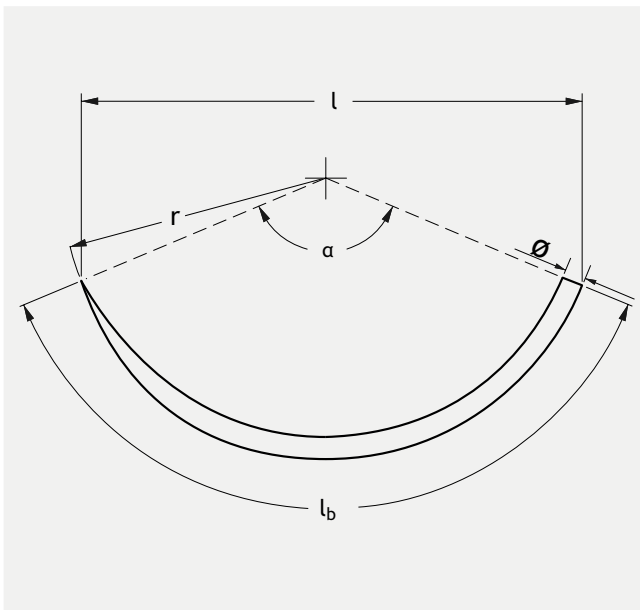

Beschreibung:

- l = Länge
- l_b = Bogenlänge
- r = Radius
- α = Winkel 135°, 3/8-Kreis
- ϕ = Nadeldurchmesser in μm

Description:

- l = Length
- l_b = Arc length
- r = Radius
- α = Angle 135°, 3/8 circle
- ϕ = Needle diameter in μm

Artikelnummer Beispiel Article Number Sample		Beschreibung Description	
		Anzahl der Nadeln	Quantity of needles
		Nadelform: Rundspitze in V-Form	Needle form V, with Taper Point
		Nadeldurchmesser $\phi \times 10 \mu\text{m}$	Needle diameter $\phi \times 10 \mu\text{m}$
		Nadellänge (l) in mm	Needle length (l) in mm
		Bogenlänge (l_b) in mm, 3/8-Kreis, $\alpha = 135^\circ$	Arc length (l_b) in mm, 3/8 of full circle, $\alpha = 135^\circ$
		Fadenmaterial N für Nylon, Polyamid 6.6	Suture material N for Nylon, Polyamid 6.6
		Fadendurchmesser in USP (United States Pharmacopeia)	Suture diameter in USP (United States Pharmacopeia)
2	V 10 5 3 N 10 15	Fadenlänge in cm	Suture length in cm

Unsere Mikronadeln sind in vier Varianten erhältlich. Unterschiedliche Gewebeschaffenheit stellt vielfältige Anforderungen an die Nadel beim Einstich und beim Durchziehen durch das Gewebe. Daher bieten wir Nadeln mit unterschiedlichen Spitzen und Nadelformen an.

Die Rundnadel mit V-förmiger Spitze durchsticht das Gewebe. Die schneidenden Nadeln in W-, T-, und Y-Form sind scharf und optimal für Gewebearten geeignet die einen größeren Gewebewiderstand aufweisen, wie Haut-, Narbengewebe sowie Sehnenansätze.

The micro needles are available in four different versions. As different tissue conditions strain the needle in various ways when puncturing and pulling it through the tissue, we are providing needles in different tip- and cross-section forms.

The round needle with the V-shaped tip penetrates the tissue. The cutting needles with form W, T, and Y are sharp and suitable for types of tissue showing a major tissue resistance, such as dermal tissue, cicatricial tissue and tendons.



Rundspitze, V-Form
Taper Point, form V

Eigenschaften:

Die runde Nadel durchsticht alle weichen Gewebearten ohne sie zu schneiden. Durch die schlanke Nadelspitze entsteht ein sehr kleiner Stichkanal.

Characteristics:

The round needle penetrates all of the tissue types without cutting. Due to the slight needle tip, a minimum branch canal arises.

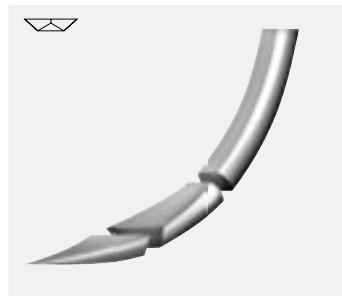

Spatula Nadel, W-Form
Spatula needle, form W

Eigenschaften:

Die scharfe Spatula Nadel schneidet mit der Nadelspitze das Gewebe. Sie verursacht daher nur eine geringe Gewebeschädigung.

Characteristics:

The sharp spatula needle cuts the tissue with the needle tip. Therefore only a marginal tissue damage is caused.



Triangel Nadel, T-Form
Triangle needle, form T

Eigenschaften:

Die scharfe Triangel Nadel schneidet entlang der gesamten Nadelkanten festes Gewebe.

Characteristics:

The sharp reverse cutting triangle needle cuts hard tissue along the entire needle edges.

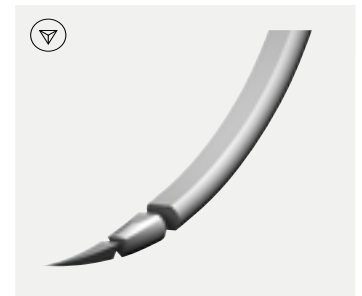

Schneidende Nadelspitze, Y-Form
Taper cutting, form Y

Eigenschaften:

Die scharfe Y-Nadel schneidet mit der Nadelspitze festes Gewebe mit sehr guter Gewebepenetration. Der Stichkanal besitzt eine Y-Form.

Characteristics:

The sharp Y needle cuts the tissue with the needle point, showing excellent tissue penetration. The branch canal has a form Y.

USP Größe / USP size: 10/0
Verfallsdatum / Date of expiry: 2015-06
Artikelnummer / Article number: No 2V1563N1015
Fadenstärke / Suture strength: metric 0,2
Fadenlänge / Suture length: 15 cm
Nadeltyp / Needle type: 2xV
Bogenlänge in mm / Arc length in mm: 7,7-150
Nadeldurchmesser in µm / Needle diameter in µm: 0123
Fadenmaterial / Suture material: NYLON BLACK
Stückzahl / Number of sachets: 12 sachets
Nicht wiederverwendbar / Not reusable
Beipackzettel beachten / Follow directions in package insert
Nadelprofil / Needle point
Nadelform / Needle shape
Chargennummer / Lot number: 07/058/16
Sterilisationsmethode (Ethylenoxid) / Method of Sterilisation (Ethylene Oxide): STERILE EO
www.micromed.biz

Micromed Etikett
Micromed Label

Mikronahtmaterial, Nadel in W-Form mit Nylon- oder Seidenfaden

Micro Sutures, Needle of form W with Nylon- or Silk Thread

Die W-förmige Mikronadel mit sehr guten Schneideigenschaften ist bestens geeignet unterschiedlich zähe Gewebeschichten exakt zu durchdringen und mit dem Nylonfaden zu verbinden.

The W-shaped micro needle with excellent tissue sectioning properties is suitable for the exact penetrating of different tenacious tissue layers and connecting them with the nylon thread.



Nadel in W-Form <i>Micro Suture, Needle of form W</i>						Nylonfaden, schwarz <i>Nylon Thread, black</i>			Seidenfaden, schwarz <i>Silk Thread, black</i>		
Nadel mit Faden <i>Needle with Thread</i>	Profil <i>Profile</i>	Ø <i>µm</i>	Länge [l] mm <i>Length</i> [l] mm	Bogenlänge [l _b] mm <i>Arc length</i> [l _b] mm	Kreis <i>Circle</i>	Länge cm <i>Length</i> cm	USP 11 - 0 Metric 0,1 Ø 0,01 mm	USP 10 - 0 Metric 0,2 Ø 0,02 mm	USP 9 - 0 Metric 0,3 Ø 0,03 mm	USP 8 - 0 Metric 0,4 Ø 0,04 mm	USP 5 - 0 Metric 1,0 Ø 0,10 mm
		100	3	3,8	3/8	15	1W1033N1115	1W1033N1015	1W1033N0915	–	–
		100	5	6,4	3/8	30	2W1053N1130	–	–	–	–
		150	4	5,1	3/8	30	–	1W1543N1030	1W1543N0930	–	–
		150	4	5,1	3/8	30	–	2W1543N1030	2W1543N0930	2W1543S0830	–
		150	4	6,3	1/2	30	–	1W1544N1030	1W1544N0930	1W1544S0830	–
		150	4	6,3	1/2	30	–	2W1544N1030	2W1544N0930	2W1544S0830	–
		150	5	6,4	3/8	30	–	–	1W1553N0930	–	–
		150	5	6,4	3/8	30	–	–	2W1553N0930	–	–
		150	5	6,4	3/8	30	2W1553N1130	2W1553N1030	–	–	–
		150	5	6,3	1/2	30	1W1554N1130	–	–	–	–
		150	5	6,3	1/2	30	–	2W1554N1030	–	–	–
		200	5	6,4	3/8	30	–	1W2053N1030	1W2053N0930	1W2053S0830	–
		200	5	6,4	3/8	30	–	2W2053N1030	2W2053N0930	2W2053S0830	–
		350	8	8,9	1/4	45	–	–	–	–	1W3582S0545
							Artikelnummer <i>Article Number</i>				

Mikronahtmaterial, Nadel mit V-förmiger Rundspitze mit Nylonfaden Micro Sutures, Taper Point with form V and Nylon Thread

Mikronahtmaterial besteht aus einer Nadel mit V-förmiger Rundspitze und schwarzem Nylonfaden. Das mikrochirurgische Nahtmaterial wurde speziell für die Mikrochirurgie zur Anwendung bei Blutgefäßen und Nerven entwickelt. Die V-förmige Geometrie der Nadelspitze und die glatte Oberfläche des Nylonfadens sorgen für kleinste Stichkanäle mit geringster Schädigung.

Micro suture consists of a needle with a V-shaped taper point and black nylon thread. The microsurgical sutures were especially produced for application to blood vessels and nerves. The V-shaped geometry of the needle tip and the smooth surface of the nylon threads ensure minimal suture holes with least damages.



Nadel mit der V-Form Micro Suture with form V						Nylonfaden, schwarz Nylon Thread, black					
Nadel mit Faden Needle with Thread	Profil Profile	Ø µm	Länge [l] mm Length [l] mm	Bogenlänge [l _b] mm Arc length [l _b] mm	Kreis Circle	Länge cm Length cm	USP 12 - 0 Metric 0,01 Ø 0,001 mm	USP 11 - 0 Metric 0,1 Ø 0,01 mm	USP 10 - 0 Metric 0,2 Ø 0,02 mm	USP 9 - 0 Metric 0,3 Ø 0,03 mm	USP 8 - 0 Metric 0,4 Ø 0,04 mm
		30	2	2,6	3/8	5	1V0323N1205	–	–	–	–
		50	2	2,6	3/8	10	1V0523N1210	1V0523N1110	1V0523N1010	–	–
		50	3	3,8	3/8	10	1V0533N1210	1V0533N1110	1V0533N1010	–	–
		70	2	2,6	3/8	10	–	–	1V0723N1010	–	–
		70	3	3,8	3/8	10	–	1V0733N1110	1V0733N1010	–	–
		70	4	5,1	3/8	10	1V0743N1210	1V0743N1110	1V0743N1010	–	–
		100	3	3,8	3/8	15	–	–	1V1033N1015	1V1033N0915	–
		100	3	3,3	1/2	15	–	1V1034N1115	1V1034N1015	1V1034N0915	–
		100	4	4,4	1/4	15	–	–	1V1042N1015	–	–
		100	4	5,1	3/8	15	–	–	1V1043N1015	1V1043N0915	1V1043N0815
		100	5	6,4	3/8	15	–	–	1V1053N1015	1V1053N0915	–
		140	3	3,8	3/8	15	–	–	1V1433N1015	1V1433N0915	1V1433N0815
		140	4	5,1	3/8	15	–	–	1V1443N1015	1V1443N0915	1V1443N0815
		140	5	6,4	3/8	15	–	–	1V1453N1015	1V1453N0915	1V1453N0815
		150	6	7,7	3/8	15	–	–	1V1563N1015	1V1563N0915	1V1563N0815
		150	6	7,7	3/8	15	–	–	2V1563N1015	2V1563N0915	–
		200	5	6,4	3/8	20	–	–	–	–	1V2053N0820
		200	8	10,2	3/8	20	–	–	–	–	1V2083N0820
							Artikelnummer Article Number				

Mikronahtmaterial, schneidende Nadel in T-Form mit Nylon- oder Seidenfaden

Micro Sutures, Needle Taper Cut of form T with Nylon- or Silk Thread

Die Mikronadel mit Triangelform besitzt optimale Schneideigenschaften und ist bestens geeignet zur Rekonstruktion von Sehnen und für feinste Nähte. Diese Nadel ist mit höchster Präzision geschliffen und bleibt somit über lange Zeit scharf. Sie liegt trotz Triangelform stabil im Nadelhalter.

The micro needle with triangle form ensures excellent tissue sectioning properties and is suitable for reconstruction of tendons and for finest fissures. This needle was sharpened with highest precision and remains sharp for a long time. Despite of its triangle form the needle lies comfortable in the needle holder.

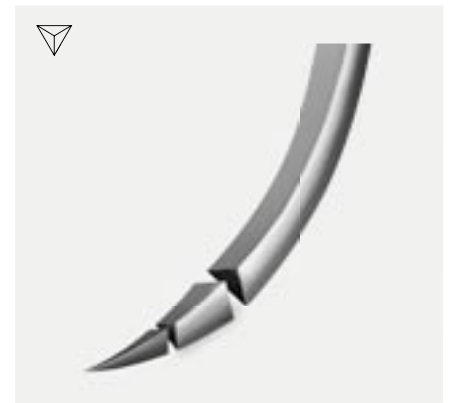

Nadel schneidend mit der T- Form Micro Sutures Taper Cut with form T						Nylonfaden, schwarz Nylon Thread, black					
Nadel mit Faden Needle with Thread	Profil Profile	Ø µm	Länge [l] mm Length [l] mm	Bogenlänge [l _b] mm Arc length [l _b] mm	Kreis Circle	Länge cm Length cm	USP 8 - 0 Metric 0,4 Ø 0,04 mm	USP 7 - 0 Metric 0,5 Ø 0,05 mm	USP 6 - 0 Metric 0,7 Ø 0,07 mm	USP 5 - 0 Metric 1,0 Ø 0,10 mm	USP 4 - 0 Metric 1,5 Ø 0,15 mm
		230	4	6,3	1/2	45	1T2344N0845	1T2344N0745	—	—	—
		230	5	6,4	3/8	45	—	—	1T2353N0645	—	—
		230	6	7,7	3/8	45	—	1T2363N0745	1T2363N0645	—	—
		250	9	11,5	3/8	45	—	1T2593N0745	1T2593N0645	—	—
		300	11	14	3/8	45	—	—	1T30113N645	1T30113N545	—
		350	11	14	3/8	45	—	—	—	—	1T35113N445
							Artikelnummer Article Number				

Nadel schneidend mit der T- Form Micro Sutures Taper Cut with form T						Seidenfaden, schwarz Silk Thread, black					
Nadel mit Faden Needle with Thread	Profil Profile	Ø µm	Länge [l] mm Length [l] mm	Bogenlänge [l _b] mm Arc length [l _b] mm	Kreis Circle	Länge cm Length cm	USP 8 - 0 Metric 0,4 Ø 0,04 mm	USP 7 - 0 Metric 0,5 Ø 0,05 mm	USP 6 - 0 Metric 0,7 Ø 0,07 mm	USP 5 - 0 Metric 1,0 Ø 0,10 mm	USP 4 - 0 Metric 1,5 Ø 0,15 mm
		230	6	7,7	3/8	45	—	1T2363S0745	1T2363S0645	—	—
		250	9	11,5	3/8	45	—	1T2593S0745	1T2393S0645	—	—
		300	11	14	3/8	45	—	—	—	1T30113S545	—
		350	11	14	3/8	45	—	—	—	—	1T35113S445
							Artikelnummer Article Number				

Mikronahtmaterial, schneidende Nadel in Y- Form mit Nylonfaden Micro Sutures, Needle Taper Cut of form Y with Nylon Thread

Die schneidende Mikronadel in Y-Form ist optimal geeignet für Gefäße und Nerven. Die schneidende Funktion wird durch den speziellen Dreikantschliff an der Nadelspitze erreicht.



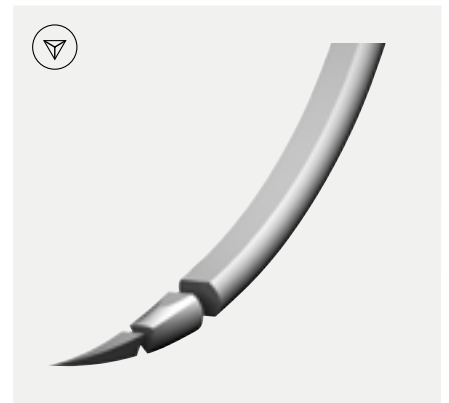





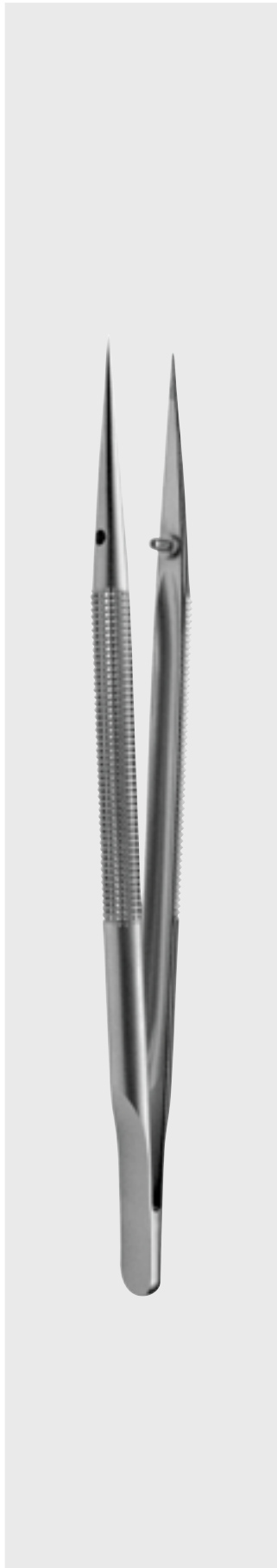

The cutting micro needle of form Y is suitable for vessels and nerves. The cutting function is achieved through the special triangular finish at the point of the needle.



Nadel mit schneidender Spitze in Y-Form Micro Sutures with Taper Cut and form Y						Nylonfaden, schwarz Nylon Thread, black					
Nadel mit Faden Needle with Thread	Profil Profile	Ø µm	Länge [l] mm Length [l] mm	Bogenlänge [l _b] mm Arc length [l _b] mm	Kreis Circle	Länge cm Length cm	USP 11 - 0 Metric 0,1 Ø 0,01 mm	USP 10 - 0 Metric 0,2 Ø 0,02 mm	USP 9 - 0 Metric 0,3 Ø 0,03 mm	USP 8 - 0 Metric 0,4 Ø 0,04 mm	USP 7 - 0 Metric 0,5 Ø 0,05 mm
		70	3	3,3	1/4	10	—	1Y0732N1010	—	—	—
		70	3	3,8	3/8	10	1Y0733N1110	1Y0733N1010	—	—	—
		70	4	5,1	3/8	10	—	1Y0743N1010	—	—	—
		100	3	3,8	3/8	15	—	1Y1033N1015	1Y1033N0915	—	—
		100	4	4,4	1/4	15	—	1Y1042N1015	—	—	—
		100	4	5,1	3/8	15	—	1Y1043N1015	1Y1043N0915	—	—
		100	5	6,4	3/8	20	—	1Y1053N1020	1Y1053N0920	—	—
		140	3	3,8	3/8	15	—	1Y1433N1015	1Y1433N0915	1Y1433N0815	—
		140	5	5,6	1/4	15	—	—	1Y1452N0915	—	—
		140	5	6,4	3/8	15	—	1Y1453N1015	1Y1453N0915	1Y1453N0815	—
		150	6	7,7	3/8	20	—	—	1Y1563N0920	1Y1563N0820	—
		150	6	7,7	3/8	45	—	—	2Y1563N0945	2Y1563N0845	—
		200	5	6,4	3/8	15	—	—	—	1Y2053N0815	—
		200	7	8,9	3/8	45	—	—	—	—	1Y2073N0845
							Artikelnummer Article Number				







Pinzetten mit Rundgriff Forceps with Round Handle

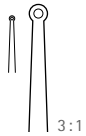
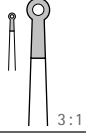
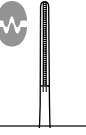

Modell Pattern	Artikel in verschiedenen Längen Article in different lengths	120 mm	150 mm	180 mm	210 mm
0,1 mm 	Pinzette mit Plateau, Spitze glatt <i>Forceps with plateau, tip smooth</i> Pinzette, Spitze diamantiert <i>Forceps, tip diamond-coated</i>	— —	301-010-115 302-010-115	301-010-118 302-010-118	— —
0,3 mm 	Pinzette mit Plateau, Spitze glatt <i>Forceps with plateau, tip smooth</i> Pinzette, Spitze diamantiert <i>Forceps, tip diamond-coated</i>	301-010-312 302-010-312	301-010-315 302-010-315	301-010-318 302-010-318	— —
0,6 mm 	Pinzette mit Plateau, Spitze glatt <i>Forceps with plateau, tip smooth</i> Pinzette, Spitze diamantiert <i>Forceps, tip diamond-coated</i> Pinzette, Spitze diamantiert, Titan <i>Forceps, tip diamond-coated, titanium</i>	— — —	301-010-615 302-010-615 303-010-615	301-010-618 302-010-618 303-010-618	301-010-621 302-010-621 303-010-621
0,8 mm 	Pinzette mit Plateau, Spitze glatt <i>Forceps with plateau, tip smooth</i> Pinzette, Spitze diamantiert <i>Forceps, tip diamond-coated</i> Pinzette, Spitze diamantiert, Titan <i>Forceps, tip diamond-coated, titanium</i>	— — —	301-010-815 302-010-815 303-010-815	301-010-818 302-010-818 303-010-818	301-010-821 302-010-821 303-010-821
0,3 mm 	Pinzette schmal, Spitze glatt <i>Forceps slim, tip smooth</i> Pinzette schmal, Spitze diamantiert <i>Forceps slim, tip diamond-coated</i>	— —	301-020-315 302-020-315	— —	— —
0,3 mm 	Pinzette, Spitze glatt <i>Forceps, tip smooth</i> Pinzette, Spitze diamantiert <i>Forceps, tip diamond-coated</i> Pinzette, Spitze diamantiert, Titan <i>Forceps, tip diamond-coated, titanium</i>	— — —	301-030-315 302-030-315 303-030-315	301-030-318 302-030-318 303-030-318	— — —
0,35 mm 	Pinzette gerade, Dilator <i>Forceps straight, dilator</i>	—	301-040-315	301-040-318	—
0,3 mm 	Pinzette gerade, mit Mauszahn <i>Forceps straight, with mouse tooth</i>	301-050-312	301-050-315	301-050-318	301-050-321
0,3 mm 	Pinzette gerade, schmal, mit Mauszahn <i>Forceps straight, slim, with mouse tooth</i>	—	301-060-315	—	—
0,6 mm 	Pinzette gerade, nach Pierce, Bohrung Ø 0,3 mm <i>Forceps straight, according to Pierce, drilling Ø 0,3 mm</i>	—	301-070-615	301-070-618	—

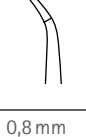
Pinzetten mit Rundgriff Forceps with Round Handle

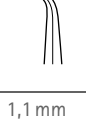







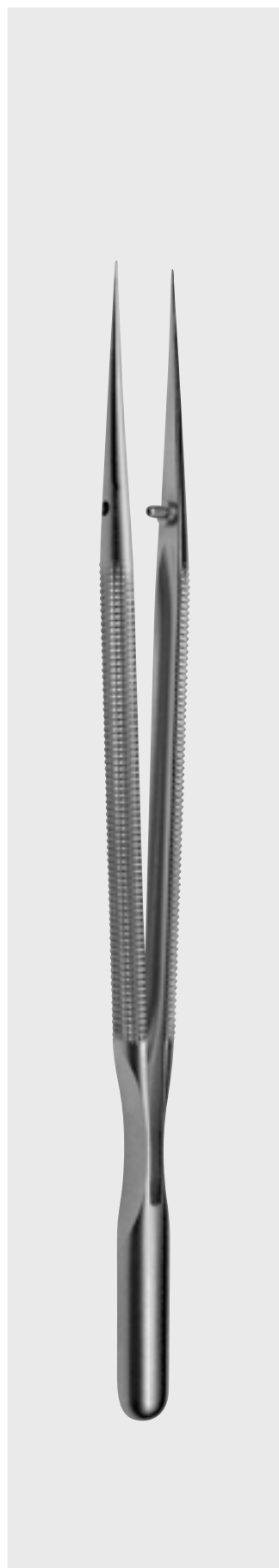



Modell Pattern	Artikel in verschiedenen Längen Article in different lengths	120 mm	150 mm	180 mm	210 mm
Ø 0,8x0,4 mm 	Pinzette gerade mit Ring <i>Forceps straight with ring</i> Pinzette, Ring diamantiert <i>Forceps, ring diamond-coated</i> Pinzette gerade mit Ring, Titan <i>Forceps straight with ring, titanium</i>	—	301-080-815	301-080-818	301-080-821
	Pinzette, Ring diamantiert <i>Forceps, ring diamond-coated</i>	—	302-080-815	302-080-818	302-080-821
	Pinzette gerade mit Ring, Titan <i>Forceps straight with ring, titanium</i>	—	—	—	—
Ø 1,0x0,5 mm 	Pinzette gerade mit Ring <i>Forceps straight with ring</i> Pinzette, Ring diamantiert <i>Forceps, ring diamond-coated</i> Pinzette gerade, Titan mit Ring <i>Forceps straight with ring, titanium</i>	—	301-081-015	301-081-018	301-081-021
	Pinzette, Ring diamantiert <i>Forceps, ring diamond-coated</i>	—	302-081-015	302-081-018	302-081-021
	Pinzette gerade, Titan mit Ring <i>Forceps straight with ring, titanium</i>	—	303-081-015	303-081-018	303-081-021
1,1 mm 	Pinzette gerade, atraumatisch <i>Forceps straight, atraumatic</i>	—	301-091-115	301-091-118	301-091-121
	Pinzette gerade, atraumatisch, Titan <i>Forceps straight, atraumatic, titanium</i>	—	—	303-091-118	303-091-121
0,3 mm 	Pinzette abgewinkelt, Spitze glatt <i>Forceps angulated, tip smooth</i>	301-100-312	301-100-315	301-100-318	—
	Pinzette abgewinkelt, Spitze diamantiert <i>Forceps angulated, tip diamond-coated</i>	302-100-312	302-100-315	302-100-318	—
0,3 mm 	Pinzette abgewinkelt mit Mauszahn <i>Forceps angulated with mouse tooth</i>	301-150-312	301-150-315	301-150-318	301-150-321
0,6 mm 	Pinzette mit Plateau, Spitze glatt <i>Forceps with plateau, tip smooth</i> Pinzette mit Plateau, Spitze diamantiert <i>Forceps with plateau, tip coated</i> Pinzette, Spitze diamantiert, Titan <i>Forceps, tip diamond-coated, titanium</i>	—	301-110-615	301-110-618	301-110-621
	Pinzette mit Plateau, Spitze diamantiert <i>Forceps with plateau, tip coated</i>	—	302-110-615	302-110-618	302-110-621
	Pinzette, Spitze diamantiert, Titan <i>Forceps, tip diamond-coated, titanium</i>	—	303-110-615	303-110-618	303-110-621
0,8 mm 	Pinzette mit Plateau, Spitze glatt <i>Forceps with plateau, tip smooth</i> Pinzette mit Plateau, diamantiert <i>Forceps with plateau, tip coated</i> Pinzette, Spitze diamantiert, Titan <i>Forceps, tip diamond-coated, titanium</i>	—	301-110-815	301-110-818	301-110-821
	Pinzette mit Plateau, diamantiert <i>Forceps with plateau, tip coated</i>	—	302-110-815	302-110-818	302-110-821
	Pinzette, Spitze diamantiert, Titan <i>Forceps, tip diamond-coated, titanium</i>	—	303-110-815	303-110-818	303-110-821
1,0 mm 	Pinzette mit Plateau, Spitze glatt <i>Forceps with plateau, tip smooth</i> Pinzette mit Plateau, diamantiert <i>Forceps with plateau, tip coated</i> Pinzette, Spitze diamantiert, Titan <i>Forceps, tip diamond-coated, titanium</i>	—	301-111-015	301-111-018	301-111-021
	Pinzette mit Plateau, diamantiert <i>Forceps with plateau, tip coated</i>	—	302-111-015	302-111-018	302-111-021
	Pinzette, Spitze diamantiert, Titan <i>Forceps, tip diamond-coated, titanium</i>	—	303-111-015	303-111-018	303-111-021
0,5 mm 	Pinzette aufwärts gebogen <i>Forceps upward curved</i>	—	301-120-515	301-120-518	—
1,1 mm 	Pinzette abgewinkelt, atraumatisch <i>Forceps angulated, atraumatic</i>	—	301-131-115	301-131-118	301-131-121

Pinzetten mit Rundgriff und Gegengewicht

Forceps with Round Handle and Counter Balance



Modell Pattern	Artikel in verschiedenen Längen Article in different lengths	150 mm	180 mm	210 mm	230 mm
0,1 mm 	Pinzette mit Plateau, Spitze glatt <i>Forceps with plateau, tip smooth</i> Pinzette, Spitze diamantiert <i>Forceps, tip diamond-coated</i>	311-010-115 312-010-115	311-010-118 312-010-118	— —	— —
0,3 mm 	Pinzette mit Plateau, Spitze glatt <i>Forceps with plateau, tip smooth</i> Pinzette, Spitze diamantiert <i>Forceps, tip diamond-coated</i>	311-010-315 312-010-315	311-010-318 312-010-318	— —	— —
0,6 mm 	Pinzette mit Plateau, Spitze glatt <i>Forceps with plateau, tip smooth</i> Pinzette, Spitze diamantiert <i>Forceps, tip diamond-coated</i> Pinzette, Spitze diamantiert, Titan <i>Forceps, tip diamond-coated, titanium</i>	311-010-615 312-010-615 313-010-615	311-010-618 312-010-618 313-010-618	311-010-621 312-010-621 313-010-621	— — —
0,8 mm 	Pinzette mit Plateau, Spitze glatt <i>Forceps with plateau, tip smooth</i> Pinzette, Spitze diamantiert <i>Forceps, tip diamond-coated</i> Pinzette, Spitze diamantiert, Titan <i>Forceps, tip diamond-coated, titanium</i>	311-010-815 312-010-815 313-010-815	311-010-818 312-010-818 313-010-818	311-010-821 312-010-821 313-010-821	311-010-823 312-010-823 313-010-823
0,3 mm 	Pinzette schmal mit Plateau, Spitze glatt <i>Forceps slim with plateau, tip smooth</i> Pinzette schmal, Spitze diamantiert <i>Forceps slim, tip diamond-coated</i>	311-020-315 312-020-315	— —	— —	— —
0,3 mm 	Pinzette, Spitze glatt <i>Forceps, tip smooth</i> Pinzette, Spitze diamantiert <i>Forceps, tip diamond-coated</i> Pinzette, Spitze diamantiert, Titan <i>Forceps, tip diamond-coated, titanium</i>	311-030-315 312-030-315 313-030-315	311-030-318 312-030-318 —	— — —	— — —
0,35 mm 	Pinzette gerade, Dilator <i>Forceps straight, dilator</i>	311-040-315	311-040-318	—	—
0,3 mm 	Pinzette gerade mit Mauszahn <i>Forceps straight with mouse tooth</i>	311-050-315	311-050-318	311-050-321	—
0,3 mm 	Pinzette gerade, schmal mit Mauszahn <i>Forceps straight, slim, with mouse tooth</i>	—	311-060-318	—	—
0,6 mm 	Pinzette gerade, nach Pierce, Bohrung Ø 0,3 mm <i>Forceps straight, according to Pierce, drilling Ø 0,3 mm</i>	311-070-615	311-070-618	—	—

Pinzetten mit Rundgriff und Gegengewicht Forceps with Round Handle and Counter Balance

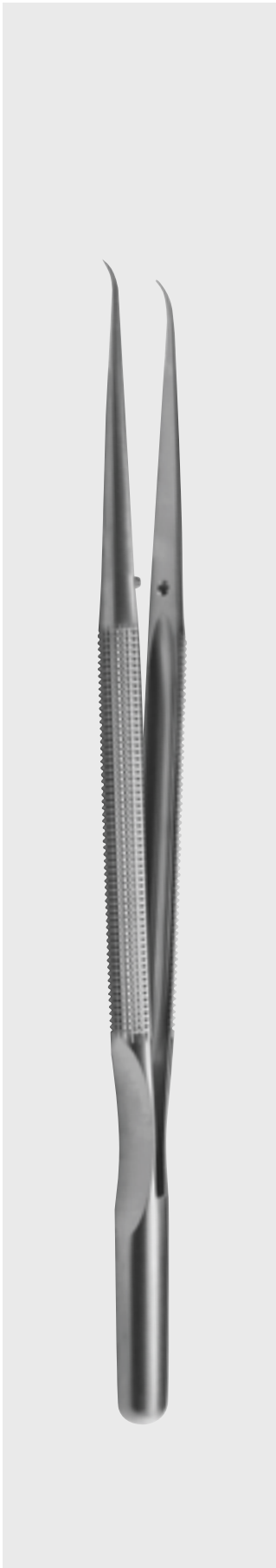







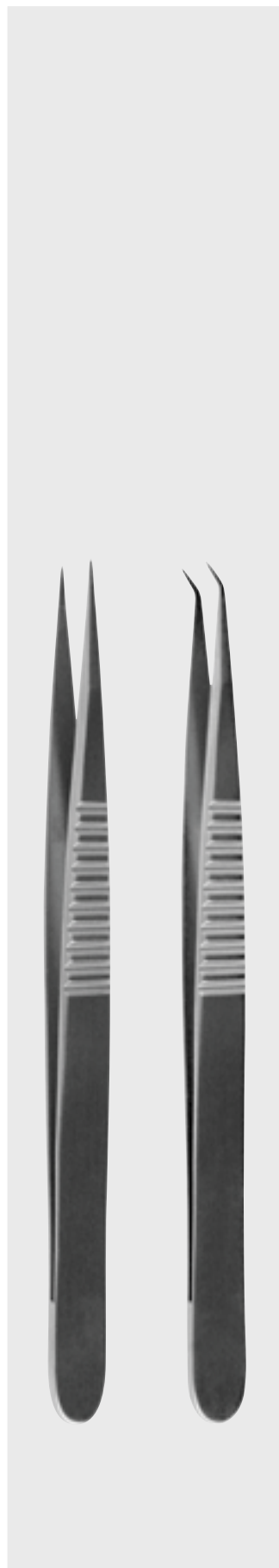



Modell Pattern	Artikel in verschiedenen Längen Article in different lengths	120 mm	150 mm	180 mm	210 mm
Ø 0,8x0,4 mm 	Pinzette gerade mit Ring <i>Forceps straight with ring</i> Pinzette gerade mit Ring, Titan <i>Forceps straight with ring, titanium</i>	-	311-080-815	-	311-080-821
Ø 1,0x0,5 mm 	Pinzette gerade mit Ring <i>Forceps straight with ring</i> Pinzette gerade mit Ring, Titan <i>Forceps straight with ring, titanium</i>	-	311-081-015	311-081-018	311-081-021
1,1 mm 	Pinzette gerade, atraumatisch <i>Forceps straight, atraumatic</i> Pinzette gerade, atraumatisch, Titan <i>Forceps straight, atraumatic, titanium</i>	-	311-091-115	311-091-118	311-091-121
0,3 mm 	Pinzette abgewinkelt, Spitze glatt <i>Forceps angulated, tip smooth</i> Pinzette, Spitze diamantiert <i>Forceps, tip diamond-coated</i>	-	311-100-315	311-100-318	-
0,3 mm 	Pinzette abgewinkelt mit Mauszahn <i>Forceps angulated with mouse tooth</i>	-	-	311-150-318	311-150-321
0,6 mm 	Pinzette mit Plateau, Spitze glatt <i>Forceps with plateau, tip smooth</i> Pinzette mit Plateau diamantiert <i>Forceps with plateau diamond-coated</i> Pinzette, Spitze diamantiert, Titan <i>Forceps, tip diamond-coated, titanium</i>	-	311-110-615	311-110-618	311-110-621
0,8 mm 	Pinzette mit Plateau, Spitze glatt <i>Forceps with plateau, tip smooth</i> Pinzette mit Plateau diamantiert <i>Forceps with plateau diamond-coated</i> Pinzette, Spitze diamantiert, Titan <i>Forceps, tip diamond-coated, titanium</i>	-	311-110-815	311-110-818	311-110-821
1,0 mm 	Pinzette mit Plateau, Spitze glatt <i>Forceps with plateau, tip smooth</i> Pinzette mit Plateau diamantiert <i>Forceps with plateau diamond-coated</i> Pinzette, Spitze diamantiert, Titan <i>Forceps, tip diamond-coated, titanium</i>	-	311-111-015	311-111-018	311-111-021
0,5 mm 	Pinzette aufwärts gebogen <i>Forceps upward curved</i>	-	-	311-120-518	-
1,1 mm 	Pinzette abgewinkelt, atraumatisch <i>Forceps angulated, atraumatic</i>	-	311-131-115	-	311-131-121

Pinzetten mit Flachgriff











Forceps with Flat Handle



Modell Pattern	Artikel in verschiedenen Längen Article in different lengths	110 mm	135 mm	150 mm	180 mm
0,3 mm 	Pinzette mit Plateau, Spitze glatt <i>Forceps with plateau, tip smooth</i> Pinzette mit Plateau, Spitze diamantiert <i>Forceps with plateau, tip diamond-coated</i>	— —	321-010-313 322-010-313	321-010-315 322-010-315	321-010-318 322-010-318
0,6 mm 	Pinzette mit Plateau, Spitze glatt <i>Forceps with plateau, tip smooth</i> Pinzette, Spitze diamantiert mit Plateau <i>Forceps with plateau, tip diamond-coated</i>	— —	321-010-613 322-010-613	321-010-615 322-010-615	321-010-618 322-010-618
0,3 mm 	Pinzette, Spitze glatt <i>Forceps, tip smooth</i> Pinzette, Spitze diamantiert <i>Forceps, tip diamond-coated</i>	321-030-311 322-030-311	321-030-313 322-030-313	321-030-315 322-030-315	321-030-318 322-030-318
0,6 mm 	Pinzette, Spitze glatt <i>Forceps, tip smooth</i> Pinzette, Spitze diamantiert <i>Forceps, tip diamond-coated</i>	321-030-611 322-030-611	321-030-613 322-030-613	321-030-615 322-030-615	321-030-618 322-030-618
0,3 mm 	Pinzette abgewinkelt mit Plateau, Spitze glatt <i>Forceps angulated with plateau, tip smooth</i> Pinzette, Spitze diamantiert <i>Forceps, tip diamond-coated</i>	321-110-311 322-110-311	321-110-313 322-110-313	321-110-315 322-110-315	321-110-318 322-110-318
0,6 mm 	Pinzette abgewinkelt mit Plateau, Spitze glatt <i>Forceps angulated with plateau, tip smooth</i> Pinzette, Spitze diamantiert <i>Forceps, tip diamond-coated</i>	— —	321-110-613 322-110-613	321-110-615 322-110-615	321-110-618 322-110-618
0,3 mm 	Pinzette abgewinkelt, Spitze glatt <i>Forceps angulated, tip smooth</i> Pinzette, Spitze diamantiert <i>Forceps, tip diamond-coated</i>	321-100-311 322-100-311	321-100-313 322-100-313	321-100-315 322-100-315	321-100-318 322-100-318
0,6 mm 	Pinzette abgewinkelt, Spitze glatt <i>Forceps angulated, tip smooth</i> Pinzette, Spitze diamantiert <i>Forceps, tip diamond-coated</i>	321-100-611 322-100-611	321-100-613 322-100-613	321-100-615 322-100-615	321-100-618 322-100-618
0,2 mm 	Pinzette gerade, Dilator <i>Forceps straight, dilator</i>	321-040-211	321-040-213	321-040-215	321-040-218
0,6 mm 	Pinzette gerade, nach Pierce, Bohrung Ø 0,3 mm <i>Forceps straight, according to Pierce, drilling Ø 0,3 mm</i>	—	321-070-613	321-070-615	—

Pinzetten mit Flachgriff Forceps with Flat Handle









Modell Pattern	Artikel in verschiedenen Längen Article in different lengths	150 mm	180 mm	210 mm	230 mm
0,3 mm 	Pinzette mit Plateau, Spitze glatt <i>Forceps with plateau, tip smooth</i> Pinzette, Spitze diamantiert <i>Forceps, tip diamond-coated</i> Pinzette, Spitze diamantiert, Titan <i>Forceps, tip diamond-coated, titanium</i>	321-210-315 322-210-315 323-210-315	321-210-318 322-210-318 323-210-318	321-210-321 322-210-321 323-210-321	— — —
0,8 mm 	Pinzette mit Plateau, Spitze glatt <i>Forceps with plateau, tip smooth</i> Pinzette, Spitze diamantiert <i>Forceps, tip diamond-coated</i> Pinzette, Spitze diamantiert, Titan <i>Forceps, tip diamond-coated, titanium</i>	321-210-815 322-210-815 323-210-815	321-210-818 322-210-818 323-210-818	321-210-821 322-210-821 323-210-821	321-210-823 322-210-823 —
0,3 mm 	Pinzette, Spitze glatt <i>Forceps, tip smooth</i> Pinzette, Spitze diamantiert <i>Forceps, tip diamond-coated</i> Pinzette, Spitze diamantiert, Titan <i>Forceps, tip diamond-coated, titanium</i>	321-230-315 322-230-315 323-230-315	321-230-318 322-230-318 323-230-318	321-230-321 322-230-321 323-230-321	— — —
0,8 mm 	Pinzette, Spitze glatt <i>Forceps, tip smooth</i> Pinzette, Spitze diamantiert <i>Forceps, tip diamond-coated</i> Pinzette, Spitze diamantiert, Titan <i>Forceps, tip diamond-coated, titanium</i>	321-230-815 322-230-815 323-230-815	321-230-818 322-230-818 323-230-818	321-230-821 322-230-821 323-230-821	321-230-823 322-230-823 —
0,3 mm 	Pinzette mit Plateau, Spitze glatt <i>Forceps with plateau, tip smooth</i> Pinzette, Spitze diamantiert <i>Forceps, tip diamond-coated</i> Pinzette, Spitze diamantiert, Titan <i>Forceps, tip diamond-coated, titanium</i>	321-310-315 322-310-315 323-310-315	321-310-318 322-310-318 323-310-318	321-310-321 322-310-321 323-310-321	321-310-323 322-310-323 —
0,8 mm 	Pinzette mit Plateau, Spitze glatt <i>Forceps with plateau, tip smooth</i> Pinzette, Spitze diamantiert <i>Forceps, tip diamond-coated</i> Pinzette, Spitze diamantiert, Titan <i>Forceps, tip diamond-coated, titanium</i>	321-310-815 322-310-815 323-310-815	321-310-818 322-310-818 323-310-818	321-310-821 322-310-821 323-310-821	321-310-823 322-310-823 —
0,3 mm 	Pinzette gebogen, Spitze glatt <i>Forceps curved, tip smooth</i> Pinzette, Spitze diamantiert <i>Forceps, tip diamond-coated</i> Pinzette, Spitze diamantiert, Titan <i>Forceps, tip diamond-coated, titanium</i>	321-200-315 322-200-315 323-200-315	321-200-318 322-200-318 323-200-318	321-200-321 322-200-321 323-200-321	— — —
0,8 mm 	Pinzette gebogen, Spitze glatt <i>Forceps curved, tip smooth</i> Pinzette, Spitze diamantiert <i>Forceps, tip diamond-coated</i> Pinzette, Spitze diamantiert, Titan <i>Forceps, tip diamond-coated, titanium</i>	321-200-815 322-200-815 323-200-815	321-200-818 322-200-818 323-200-818	321-200-821 322-200-821 323-200-821	321-200-823 322-200-823 —
Ø 1,0x0,5 mm 	Pinzette gerade mit Ring <i>Forceps straight with ring</i> Pinzette mit Ring, Spitze diamantiert <i>Forceps with ring, tip diamond-coated</i> Pinzette gerade mit Ring, Titan <i>Forceps straight with ring, titanium</i>	321-281-015 322-281-015 323-281-015	321-281-018 322-281-018 323-281-018	321-281-021 322-281-021 323-281-021	321-281-023 — —
1,1 mm 	Pinzette gerade, atraumatisch <i>Forceps straight, atraumatic</i> Pinzette, atraumatisch, Titan <i>Forceps straight, atraumatic, titanium</i>	321-291-115 323-291-115	321-291-118 323-291-118	321-291-121 323-291-121	— —

Nadelhalter gerade mit Rundgriff





Needle Holders straight with Round Handle

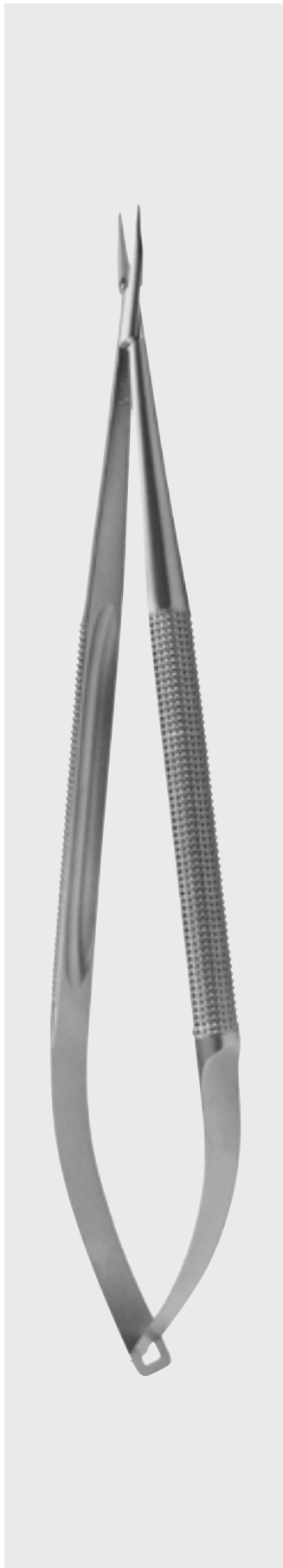

Modell Pattern	Artikel in verschiedenen Längen Article in different lengths	110 mm	125 mm	130 mm	140 mm
0,5 mm 	Nadelhalter gerade, Maul glatt <i>Needle Holder straight, jaw smooth</i> Nadelhalter mit Sperre, Maul glatt <i>Needle Holder with lock, jaw smooth</i>	—	361-010-512	—	—
Ø 7 mm	Nadelhalter gerade, Maul diamantiert <i>Needle Holder, jaw diamond coated</i> Nadelhalter mit Sperre, diamantiert <i>Needle Holder with lock, jaw coated</i>	—	362-010-512	—	—
0,2 mm 	Nadelhalter gerade, Maul glatt <i>Needle Holder straight, jaw smooth</i> Nadelhalter mit Sperre, Maul glatt <i>Needle Holder with lock, jaw smooth</i>	—	—	361-110-213	361-110-214
Ø 8 mm	Nadelhalter gerade, Maul diamantiert <i>Needle Holder, jaw diamond coated</i> Nadelhalter mit Sperre, diamantiert <i>Needle Holder with lock, jaw coated</i>	—	—	362-110-213	362-110-214
0,4 mm 	Nadelhalter gerade, Maul glatt <i>Needle Holder straight, jaw smooth</i> Nadelhalter mit Sperre, Maul glatt <i>Needle Holder with lock, jaw smooth</i>	361-110-411	—	361-110-413	—
Ø 8 mm	Nadelhalter gerade, Maul diamantiert <i>Needle Holder, jaw diamond coated</i> Nadelhalter mit Sperre, diamantiert <i>Needle Holder with lock, jaw coated</i>	362-110-411	—	362-110-413	—
0,4 mm 	Nadelhalter gerade, Maul glatt <i>Needle Holder straight, jaw smooth</i> Nadelhalter mit Sperre, Maul glatt <i>Needle Holder with lock, jaw smooth</i>	—	—	361-210-413	—
Ø 10 mm	Nadelhalter gerade, Maul diamantiert <i>Needle Holder, jaw diamond coated</i> Nadelhalter mit Sperre, diamantiert <i>Needle Holder with lock, jaw coated</i>	—	—	362-210-413	—
0,6 mm 	Nadelhalter gerade, Maul glatt <i>Needle Holder straight, jaw smooth</i> Nadelhalter mit Sperre, Maul glatt <i>Needle Holder with lock, jaw smooth</i>	—	361-110-612	—	361-110-614
Ø 8 mm	Nadelhalter gerade, Maul diamantiert <i>Needle Holder, jaw diamond coated</i> Nadelhalter mit Sperre, diamantiert <i>Needle Holder with lock, jaw coated</i>	—	362-110-612	—	362-110-614
0,8 mm 	Nadelhalter gerade, Maul glatt <i>Needle Holder straight, jaw smooth</i> Nadelhalter mit Sperre, Maul glatt <i>Needle Holder with lock, jaw smooth</i>	—	—	361-110-813	361-110-814
Ø 8 mm	Nadelhalter gerade, Maul diamantiert <i>Needle Holder, jaw diamond coated</i> Nadelhalter mit Sperre, diamantiert <i>Needle Holder with lock, jaw coated</i>	—	—	362-110-813	362-110-814

Nadelhalter gerade mit Rundgriff Needle Holders straight with Round Handle







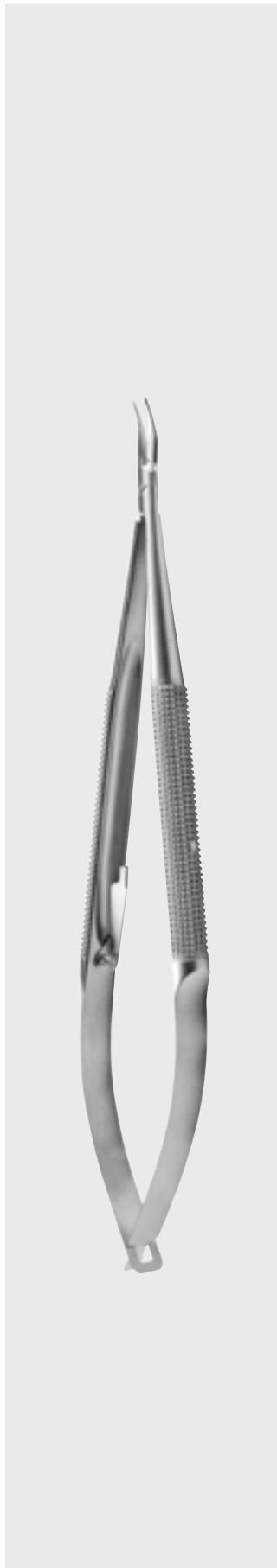

Modell Pattern	Artikel in verschiedenen Längen Article in different lengths	150 mm	180 mm	210 mm	230 mm
0,4 mm 	Nadelhalter gerade, Maul glatt <i>Needle Holder straight, jaw smooth</i>	361-110-415	—	—	—
	Nadelhalter mit Sperre, Maul glatt <i>Needle Holder with lock, jaw smooth</i>	361-120-415	—	—	—
	Nadelhalter gerade, Maul diamantiert <i>Needle Holder, jaw diamond coated</i>	362-110-415	—	—	—
	Nadelhalter mit Sperre, diamantiert <i>Needle Holder with lock, jaw coated</i>	362-120-415	—	—	—
	Nadelhalter gerade, diamantiert, Titan <i>Needle Holder, diamond coated, titanium</i>	363-110-415	—	—	—
	Nadelhalter mit Sperre, diamantiert, Titan <i>Needle Holder with lock, diamond coated, Ti</i>	363-120-415	—	—	—
Ø 8 mm					
	0,6 mm 	361-110-615	361-110-618	—	—
	Nadelhalter mit Sperre, Maul glatt <i>Needle Holder with lock, jaw smooth</i>	361-120-615	361-120-618	—	—
	Nadelhalter gerade, Maul diamantiert <i>Needle Holder, jaw diamond coated</i>	362-110-615	362-110-618	—	—
	Nadelhalter mit Sperre, diamantiert <i>Needle Holder with lock, jaw coated</i>	362-120-615	362-120-618	—	—
	Nadelhalter gerade, diamantiert, Titan <i>Needle Holder, diamond coated, titanium</i>	363-110-615	363-110-618	—	—
Ø 8 mm					
	0,6 mm 	361-210-615	361-210-618	361-210-621	361-210-623
	Nadelhalter mit Sperre, Maul glatt <i>Needle Holder with lock, jaw smooth</i>	361-220-615	361-220-618	361-220-621	361-220-623
	Nadelhalter gerade, Maul diamantiert <i>Needle Holder, jaw diamond coated</i>	362-210-615	362-210-618	362-210-621	362-210-623
	Nadelhalter mit Sperre, diamantiert <i>Needle Holder with lock, jaw coated</i>	362-220-615	362-220-618	362-220-621	362-220-623
	Nadelhalter gerade, diamantiert, Titan <i>Needle Holder, diamond coated, titanium</i>	363-210-615	363-210-618	363-210-621	363-210-623
Ø 10 mm					
	0,8 mm 	361-110-815	361-110-818	361-110-821	361-110-823
	Nadelhalter mit Sperre, Maul glatt <i>Needle Holder with lock, jaw smooth</i>	361-120-815	361-120-818	361-120-821	361-120-823
	Nadelhalter gerade, Maul diamantiert <i>Needle Holder, jaw diamond coated</i>	362-110-815	362-110-818	362-110-821	362-110-823
	Nadelhalter mit Sperre, diamantiert <i>Needle Holder with lock, jaw coated</i>	362-120-815	362-120-818	362-120-821	362-120-823
	Nadelhalter gerade, diamantiert, Titan <i>Needle Holder, diamond coated, titanium</i>	363-110-815	363-110-818	363-110-821	363-110-823
Ø 8 mm					
	1,2 mm 	—	361-111-218	361-111-221	361-111-223
	Nadelhalter mit Sperre, Maul glatt <i>Needle Holder with lock, jaw smooth</i>	—	361-121-218	361-121-221	361-121-223
	Nadelhalter gerade, Maul diamantiert <i>Needle Holder, jaw diamond coated</i>	—	362-111-218	362-111-221	362-111-223
	Nadelhalter mit Sperre, diamantiert <i>Needle Holder with lock, jaw coated</i>	—	362-121-218	362-121-221	362-121-223
	Nadelhalter gerade, diamantiert, Titan <i>Needle Holder, diamond coated, titanium</i>	—	363-111-218	363-111-221	363-111-223
Ø 8 mm					
	Nadelhalter mit Sperre, diamantiert, Titan <i>Needle Holder with lock, diamond coated, Ti</i>	—	363-121-218	363-121-221	363-121-223

Nadelhalter gebogen mit Rundgriff





Needle Holders curved with Round Handle

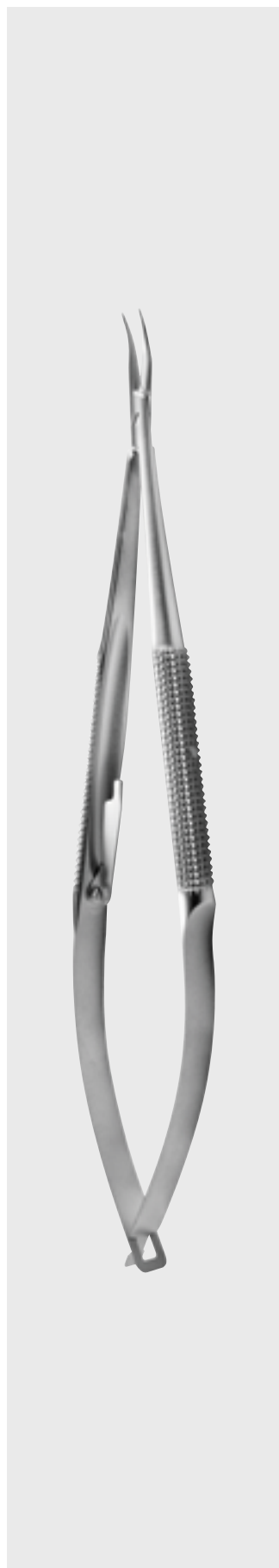

Modell Pattern	Artikel in verschiedenen Längen Article in different lengths	110 mm	125 mm	130 mm	140 mm
0,5 mm  Ø 7 mm	Nadelhalter gebogen, Maul glatt <i>Needle Holder curved, jaw smooth</i> Nadelhalter mit Sperre, Maul glatt <i>Needle Holder with lock, jaw smooth</i> Nadelhalter gebogen, Maul diamantiert <i>Needle Holder curved, jaw coated</i> Nadelhalter mit Sperre, diamantiert <i>Needle Holder with lock, jaw coated</i>	—	361-410-512	—	—
0,2 mm  Ø 8 mm	Nadelhalter gebogen, Maul glatt <i>Needle Holder curved, jaw smooth</i> Nadelhalter mit Sperre, Maul glatt <i>Needle Holder with lock, jaw smooth</i> Nadelhalter gebogen, Maul diamantiert <i>Needle Holder curved, jaw coated</i> Nadelhalter mit Sperre, diamantiert <i>Needle Holder with lock, jaw coated</i>	—	—	361-510-213	361-510-214
0,4 mm  Ø 8 mm	Nadelhalter gebogen, Maul glatt <i>Needle Holder curved, jaw smooth</i> Nadelhalter mit Sperre, Maul glatt <i>Needle Holder with lock, jaw smooth</i> Nadelhalter gebogen, Maul diamantiert <i>Needle Holder curved, jaw coated</i> Nadelhalter mit Sperre, diamantiert <i>Needle Holder with lock, jaw coated</i>	361-510-411	—	361-510-413	361-510-414
0,6 mm  Ø 8 mm	Nadelhalter gebogen, Maul glatt <i>Needle Holder curved, jaw smooth</i> Nadelhalter mit Sperre, Maul glatt <i>Needle Holder with lock, jaw smooth</i> Nadelhalter gebogen, Maul diamantiert <i>Needle Holder curved, jaw coated</i> Nadelhalter mit Sperre, diamantiert <i>Needle Holder with lock, jaw coated</i>	—	361-510-612	—	361-510-614
0,8 mm  Ø 8 mm	Nadelhalter gebogen, Maul glatt <i>Needle Holder curved, jaw smooth</i> Nadelhalter mit Sperre, Maul glatt <i>Needle Holder with lock, jaw smooth</i> Nadelhalter gebogen, Maul diamantiert <i>Needle Holder curved, jaw coated</i> Nadelhalter mit Sperre, diamantiert <i>Needle Holder with lock, jaw coated</i>	—	—	361-510-813	361-510-814
0,6 mm  Ø 8 mm	Nadelhalter gebogen konkav-konvex, rechte Hand <i>Needle Holder curved concave-convex, right hand</i> Nadelhalter gebogen, mit Sperre konkav-konvex, rechte Hand <i>Needle Holder curved, with lock concave-convex, right hand</i>	—	—	—	361-710-614
0,6 mm  Ø 8 mm	Nadelhalter gebogen konkav-konvex, linke Hand <i>Needle Holders curved concave-convex, left hand</i> Nadelhalter gebogen, mit Sperre konkav-konvex, linke Hand <i>Needle Holder curved, with lock concave-convex, left hand</i>	—	—	—	362-810-614

Nadelhalter gebogen mit Rundgriff Needle Holders curved with Round Handle







Modell Pattern	Artikel in verschiedenen Längen Article in different lengths	150 mm	180 mm	210 mm	230 mm
0,2 mm  Ø 8 mm	Nadelhalter gebogen, Maul glatt <i>Needle Holder curved, jaw smooth</i>	361-510-215	361-510-218	—	—
	Nadelhalter mit Sperre, Maul glatt <i>Needle Holder with lock, jaw smooth</i>	361-520-215	361-520-218	—	—
	Nadelhalter gebogen, Maul diamantiert <i>Needle Holder curved, jaw coated</i>	362-510-215	362-510-218	—	—
	Nadelhalter mit Sperre, diamantiert <i>Needle Holder with lock, jaw coated</i>	362-520-215	362-520-218	—	—
0,4 mm  Ø 8 mm	Nadelhalter gebogen, Maul glatt <i>Needle Holder curved, jaw smooth</i>	361-510-415	—	—	—
	Nadelhalter mit Sperre, Maul glatt <i>Needle Holder with lock, jaw smooth</i>	361-520-415	—	—	—
	Nadelhalter gebogen, Maul diamantiert <i>Needle Holder, jaw diamond coated</i>	362-510-415	—	—	—
	Nadelhalter mit Sperre, diamantiert <i>Needle Holder with lock, jaw coated</i>	362-520-415	—	—	—
0,6 mm  Ø 8 mm	Nadelhalter gebogen, Maul glatt <i>Needle Holder curved, jaw smooth</i>	361-510-615	361-510-618	361-510-621	361-510-623
	Nadelhalter mit Sperre, Maul glatt <i>Needle Holder with lock, jaw smooth</i>	361-520-615	361-520-618	361-520-621	361-520-623
	Nadelhalter gebogen, Maul diamantiert <i>Needle Holder, jaw diamond coated</i>	362-510-615	362-510-618	362-510-621	362-510-623
	Nadelhalter mit Sperre, diamantiert <i>Needle Holder with lock, jaw coated</i>	362-520-615	362-520-618	362-520-621	362-520-623
0,8 mm  Ø 8 mm	Nadelhalter gebogen, Maul glatt <i>Needle Holder curved, jaw smooth</i>	361-510-815	361-510-818	361-510-821	361-510-823
	Nadelhalter mit Sperre, Maul glatt <i>Needle Holder with lock, jaw smooth</i>	361-520-815	361-520-818	361-520-821	361-520-823
	Nadelhalter gebogen, Maul diamantiert <i>Needle Holder, jaw diamond coated</i>	362-510-815	362-510-818	362-510-821	362-510-823
	Nadelhalter mit Sperre, diamantiert <i>Needle Holder with lock, jaw coated</i>	362-520-815	362-520-818	362-520-821	362-520-823
1,2 mm  Ø 8 mm	Nadelhalter gebogen, Maul glatt <i>Needle Holder curved, jaw smooth</i>	361-511-215	361-511-218	361-511-221	361-511-223
	Nadelhalter mit Sperre, Maul glatt <i>Needle Holder with lock, jaw smooth</i>	361-521-215	361-521-218	361-521-221	361-521-223
	Nadelhalter gebogen, Maul diamantiert <i>Needle Holder, jaw diamond coated</i>	362-511-215	362-511-218	362-511-221	362-511-223
	Nadelhalter mit Sperre, diamantiert <i>Needle Holder with lock, jaw coated</i>	362-521-215	362-521-218	362-521-221	362-521-223
Ø 8 mm	Nadelhalter gebogen, diamantiert, Titan <i>Needle Holder, diamond coated, titanium</i>	363-511-215	363-511-218	363-511-221	363-511-223
	Nadelhalter mit Sperre, diamantiert, Titan <i>Needle Holder with lock, diamond coated, Ti</i>	363-521-215	363-521-218	363-521-221	363-521-223

Nadelhalter gerade mit Flachgriff





Needle Holders straight with Flat Handle

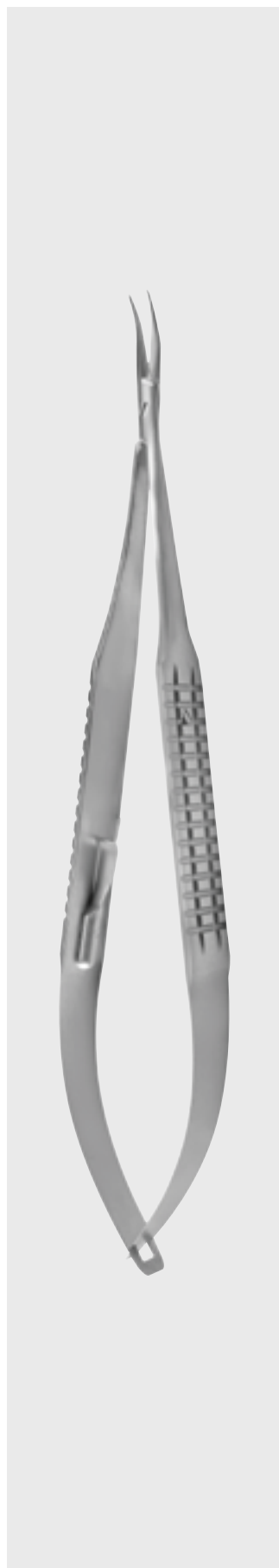

Modell Pattern	Artikel in verschiedenen Längen Article in different lengths	120 mm	140 mm	150 mm	180 mm
0,3 mm 	Nadelhalter gerade, Maul glatt <i>Needle Holder straight, jaw smooth</i>	371-210-312	—	—	—
	Nadelhalter mit Sperre, Maul glatt <i>Needle Holder with lock, jaw smooth</i>	371-220-312	—	—	—
	Nadelhalter gerade, Maul diamantiert <i>Needle Holder, jaw diamond coated</i>	372-210-312	—	—	—
	Nadelhalter mit Sperre, diamantiert <i>Needle Holder with lock, jaw coated</i>	372-220-312	—	—	—
	Nadelhalter gerade, diamantiert, Titan <i>Needle Holder, diamond coated, titanium</i>	—	—	—	—
	Nadelhalter mit Sperre, diamantiert, Titan <i>Needle Holder with lock, diamond coated, Ti</i>	—	—	—	—
10 mm	Nadelhalter gerade, Maul glatt <i>Needle Holder straight, jaw smooth</i>	371-210-612	371-210-614	—	—
	Nadelhalter mit Sperre, Maul glatt <i>Needle Holder with lock, jaw smooth</i>	371-220-612	371-220-614	—	—
	Nadelhalter gerade, Maul diamantiert <i>Needle Holder, jaw diamond coated</i>	372-210-612	372-210-614	—	—
	Nadelhalter mit Sperre, diamantiert <i>Needle Holder with lock, jaw coated</i>	372-220-612	372-220-614	—	—
	Nadelhalter gerade, diamantiert, Titan <i>Needle Holder, diamond coated, titanium</i>	—	—	—	—
	Nadelhalter mit Sperre, diamantiert, Titan <i>Needle Holder with lock, diamond coated, Ti</i>	—	—	—	—
0,6 mm 	Nadelhalter gerade, Maul glatt <i>Needle Holder straight, jaw smooth</i>	371-210-812	371-210-814	—	—
	Nadelhalter mit Sperre, Maul glatt <i>Needle Holder with lock, jaw smooth</i>	371-220-812	371-220-814	—	—
	Nadelhalter gerade, Maul diamantiert <i>Needle Holder, jaw diamond coated</i>	372-210-812	372-210-814	—	—
	Nadelhalter mit Sperre, diamantiert <i>Needle Holder with lock, jaw coated</i>	372-220-812	372-220-814	—	—
	Nadelhalter gerade, diamantiert, Titan <i>Needle Holder, diamond coated, titanium</i>	—	—	—	—
	Nadelhalter mit Sperre, diamantiert, Titan <i>Needle Holder with lock, diamond coated, Ti</i>	—	—	—	—
10 mm	Nadelhalter gerade, Maul glatt <i>Needle Holder straight, jaw smooth</i>	371-211-012	371-211-014	371-211-015	371-211-018
	Nadelhalter mit Sperre, Maul glatt <i>Needle Holder with lock, jaw smooth</i>	371-221-012	371-221-014	371-221-015	371-221-018
	Nadelhalter gerade, Maul diamantiert <i>Needle Holder, jaw diamond coated</i>	372-211-012	372-211-014	372-211-015	372-211-018
	Nadelhalter mit Sperre, diamantiert <i>Needle Holder with lock, jaw coated</i>	372-221-012	372-221-014	372-221-015	372-221-018
	Nadelhalter gerade, diamantiert, Titan <i>Needle Holder, diamond coated, titanium</i>	—	—	373-211-015	373-211-018
	Nadelhalter mit Sperre, diamantiert, Titan <i>Needle Holder with lock, diamond coated, Ti</i>	—	—	373-221-015	373-221-018
0,8 mm 	Nadelhalter gerade, Maul glatt <i>Needle Holder straight, jaw smooth</i>	371-211-012	371-211-014	371-211-015	371-211-018
	Nadelhalter mit Sperre, Maul glatt <i>Needle Holder with lock, jaw smooth</i>	371-221-012	371-221-014	371-221-015	371-221-018
	Nadelhalter gerade, Maul diamantiert <i>Needle Holder, jaw diamond coated</i>	372-211-012	372-211-014	372-211-015	372-211-018
	Nadelhalter mit Sperre, diamantiert <i>Needle Holder with lock, jaw coated</i>	372-221-012	372-221-014	372-221-015	372-221-018
	Nadelhalter gerade, diamantiert, Titan <i>Needle Holder, diamond coated, titanium</i>	—	—	373-211-015	373-211-018
	Nadelhalter mit Sperre, diamantiert, Titan <i>Needle Holder with lock, diamond coated, Ti</i>	—	—	373-221-015	373-221-018
1,0 mm 	Nadelhalter gerade, Maul glatt <i>Needle Holder straight, jaw smooth</i>	371-211-012	371-211-014	371-211-015	371-211-018
	Nadelhalter mit Sperre, Maul glatt <i>Needle Holder with lock, jaw smooth</i>	371-221-012	371-221-014	371-221-015	371-221-018
	Nadelhalter gerade, Maul diamantiert <i>Needle Holder, jaw diamond coated</i>	372-211-012	372-211-014	372-211-015	372-211-018
	Nadelhalter mit Sperre, diamantiert <i>Needle Holder with lock, jaw coated</i>	372-221-012	372-221-014	372-221-015	372-221-018
	Nadelhalter gerade, diamantiert, Titan <i>Needle Holder, diamond coated, titanium</i>	—	—	373-211-015	373-211-018
	Nadelhalter mit Sperre, diamantiert, Titan <i>Needle Holder with lock, diamond coated, Ti</i>	—	—	373-221-015	373-221-018

Nadelhalter gebogen mit Flachgriff Needle Holders curved with Flat Handle













Modell Pattern	Artikel in verschiedenen Längen Article in different lengths	120 mm	140 mm	150 mm	180 mm
0,3 mm 	Nadelhalter gebogen, Maul glatt <i>Needle Holder curved, jaw smooth</i>	371-610-312	371-610-314	—	—
	Nadelhalter mit Sperre, Maul glatt <i>Needle Holder with lock, jaw smooth</i>	371-620-312	371-620-314	—	—
	Nadelhalter gebogen, Maul diamantiert <i>Needle Holder, jaw diamond coated</i>	372-610-312	372-010-314	—	—
	Nadelhalter mit Sperre, diamantiert <i>Needle Holder with lock, jaw coated</i>	372-620-312	372-020-314	—	—
	Nadelhalter gebogen, diamantiert, Titan <i>Needle Holder, diamond coated, titanium</i>	—	—	—	—
	Nadelhalter mit Sperre, diamantiert, Titan <i>Needle Holder with lock, diamond coated, Ti</i>	—	—	—	—
10 mm 	Nadelhalter gebogen, Maul glatt <i>Needle Holder curved, jaw smooth</i>	371-610-612	371-610-614	371-610-615	371-610-618
	Nadelhalter mit Sperre, Maul glatt <i>Needle Holder with lock, jaw smooth</i>	371-620-612	371-620-614	371-620-615	371-620-618
	Nadelhalter gebogen, Maul diamantiert <i>Needle Holder, jaw diamond coated</i>	372-610-612	372-610-614	372-610-615	372-610-618
	Nadelhalter mit Sperre, diamantiert <i>Needle Holder with lock, jaw coated</i>	372-620-612	372-620-614	372-620-615	372-620-618
	Nadelhalter gebogen, diamantiert, Titan <i>Needle Holder, diamond coated, titanium</i>	—	—	373-610-615	373-610-618
	Nadelhalter mit Sperre, diamantiert, Titan <i>Needle Holder with lock, diamond coated, Ti</i>	—	—	373-620-615	373-620-618
10 mm 	Nadelhalter gebogen, Maul glatt <i>Needle Holder curved, jaw smooth</i>	371-610-812	371-610-814	371-610-815	371-610-818
	Nadelhalter mit Sperre, Maul glatt <i>Needle Holder with lock, jaw smooth</i>	371-620-812	371-620-814	371-620-815	371-620-818
	Nadelhalter gebogen, Maul diamantiert <i>Needle Holder, jaw diamond coated</i>	372-610-812	372-610-814	372-610-815	372-610-818
	Nadelhalter mit Sperre, diamantiert <i>Needle Holder with lock, jaw coated</i>	372-620-812	372-620-814	372-620-815	372-620-818
	Nadelhalter gebogen, diamantiert, Titan <i>Needle Holder, diamond coated, titanium</i>	—	—	373-610-815	373-610-818
	Nadelhalter mit Sperre, diamantiert, Titan <i>Needle Holder with lock, diamond coated, Ti</i>	—	—	373-620-815	373-620-818
1,0 mm 	Nadelhalter gebogen, Maul glatt <i>Needle Holder curved, jaw smooth</i>	371-611-012	371-611-014	371-611-015	371-611-018
	Nadelhalter mit Sperre, Maul glatt <i>Needle Holder with lock, jaw smooth</i>	371-621-012	371-621-014	371-621-015	371-621-018
	Nadelhalter gebogen, Maul diamantiert <i>Needle Holder, jaw diamond coated</i>	372-611-012	372-611-014	372-611-015	372-611-018
	Nadelhalter mit Sperre, diamantiert <i>Needle Holder with lock, jaw coated</i>	372-621-012	372-621-014	372-621-015	372-621-018
	Nadelhalter gebogen, diamantiert, Titan <i>Needle Holder, diamond coated, titanium</i>	—	—	373-611-015	373-611-018
	Nadelhalter mit Sperre, diamantiert, Titan <i>Needle Holder with lock, diamond coated, Ti</i>	—	—	373-621-015	373-621-018

Scheren gerade mit Rundgriff

Scissors straight with Round Handle









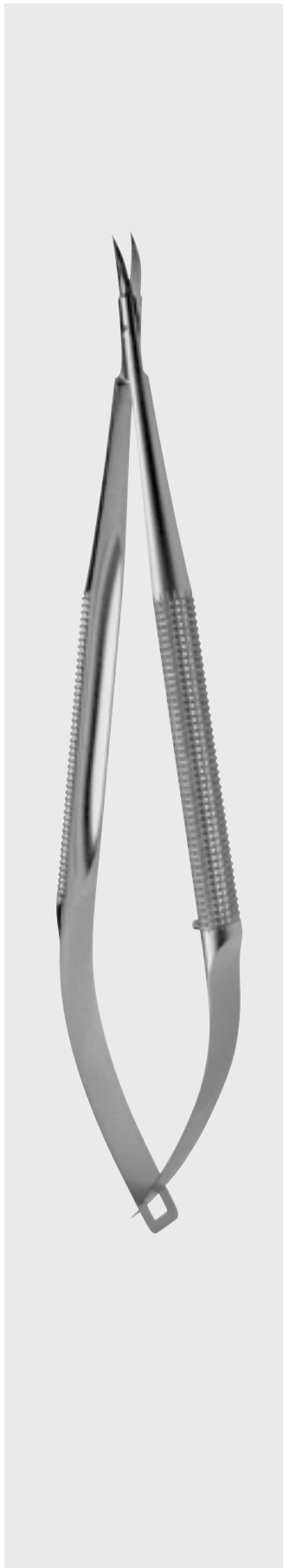



Modell Pattern	Artikel in verschiedenen Längen Article in different lengths	125 mm	150 mm	180 mm	210 mm
6 mm 	Schere gerade, Vannas Handgriff Ø 7 mm Scherenblatt 6 mm <i>Scissors straight, Vannas</i> <i>Handle Ø 7 mm, scissor blade 6 mm</i>	381-010-612	—	—	—
9 mm 	Schere gerade, Castroviejo Handgriff Ø 7 mm Scherenblatt 9 mm <i>Scissors straight, Castroviejo</i> <i>Handle Ø 7 mm, scissor blade 9 mm</i>	381-020-912	—	—	—
10 mm 	Schere gerade Handgriff Ø 8 mm Scherenblatt 10 mm <i>Scissors straight</i> <i>Handle Ø 8 mm</i> <i>Scissor blade 10 mm</i>	—	381-031-015	—	—
10 mm 	Präparierschere, gerade Handgriff Ø 8 mm Scherenblatt 10 mm <i>Dissecting scissors, straight</i> <i>Handle Ø 8 mm</i> <i>Scissor blade 10 mm</i>	—	381-041-015	—	—
10 mm 	Schere gerade, gezahnt Handgriff Ø 8 mm Scherenblatt 10 mm <i>Scissors straight, serrated</i> <i>Handle Ø 8 mm</i> <i>Scissor blade 10 mm</i>	—	381-051-015	—	—
10 mm 	Schere gerade, Vannas Handgriff Ø 8 mm Scherenblatt 10 mm <i>Scissors straight, Vannas</i> <i>Handle Ø 8 mm</i> <i>Scissor blade 10 mm</i>	—	381-061-015	381-061-018	381-061-021
11 mm 	Schere gerade Handgriff Ø 8 mm Scherenblatt 11 mm <i>Scissors straight</i> <i>Handle Ø 8 mm</i> <i>Scissor blade 11 mm</i>	—	—	381-071-118	381-071-121
11 mm 	Schere gerade, gezahnt Handgriff Ø 8 mm Scherenblatt 11 mm <i>Scissors straight, serrated</i> <i>Handle Ø 8 mm</i> <i>Scissor blade 11 mm</i>	—	—	381-081-118	—
13 mm 	Schere gerade, längeres Blatt Handgriff Ø 8 mm Scherenblatt 13 mm <i>Scissors straight, longer blade</i> <i>Handle Ø 8 mm</i> <i>Scissor blade 13 mm</i>	—	381-091-315	—	381-091-321
13 mm 	Schere gerade, gezahnt, längeres Blatt Handgriff Ø 8 mm Scherenblatt 13 mm <i>Scissors straight, serrated, longer blade</i> <i>Handle Ø 8 mm</i> <i>Scissor blade 13 mm</i>	—	381-101-315	381-101-318	381-101-321



Scheren gebogen mit Rundgriff Scissors curved with Round Handle







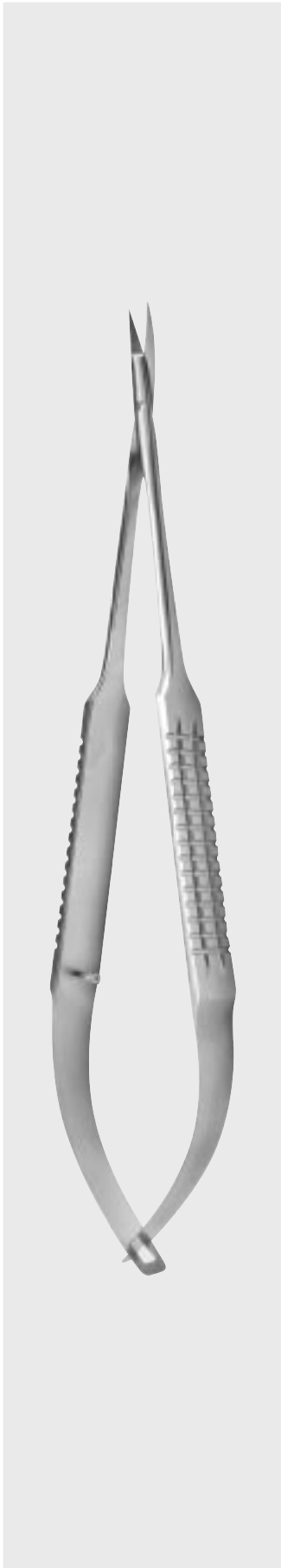

Modell Pattern	Artikel in verschiedenen Längen Article in different lengths	125 mm	150 mm	180 mm	210 mm
6 mm 	Schere gebogen, Vannas Handgriff Ø 7 mm Scherenblatt 6 mm <i>Scissors curved, Vannas</i> <i>Handle Ø 7 mm, scissor blade 6 mm</i>	381-110-612	—	—	—
9 mm 	Schere gebogen, Castroviejo Handgriff Ø 7 mm, Scherenblatt 9 mm <i>Scissors curved, Castroviejo</i> <i>Handle Ø 7 mm, scissor blade 9 mm</i>	381-120-912	—	—	—
10 mm 	Schere gebogen Handgriff Ø 8 mm Scherenblatt 10 mm <i>Scissors curved</i> <i>Handle Ø 8 mm</i> <i>Scissor blade 10 mm</i>	—	381-131-015	—	—
10 mm 	Präparierschere gebogen Handgriff Ø 8 mm Scherenblatt 10 mm <i>Dissecting scissors, curved</i> <i>Handle Ø 8 mm</i> <i>Scissor blade 10 mm</i>	—	381-141-015	—	—
10 mm 	Schere gebogen, gezahnt Handgriff Ø 8 mm Scherenblatt 10 mm <i>Scissors curved, serrated</i> <i>Handle Ø 8 mm</i> <i>Scissor blade 10 mm</i>	—	381-151-015	—	—
10 mm 	Schere gebogen, Vannas Handgriff Ø 8 mm Scherenblatt 10 mm <i>Scissors curved, Vannas</i> <i>Handle Ø 8 mm</i> <i>Scissor blade 10 mm</i>	—	381-161-015	381-161-018	381-161-021
11 mm 	Schere gebogen Handgriff Ø 8 mm Scherenblatt 11 mm <i>Scissors curved</i> <i>Handle Ø 8 mm</i> <i>Scissor blade 11 mm</i>	—	—	381-171-118	381-171-121
11 mm 	Schere gebogen, gezahnt Handgriff Ø 8 mm Scherenblatt 11 mm <i>Scissors curved, serrated</i> <i>Handle Ø 8 mm</i> <i>Scissor blade 11 mm</i>	—	—	381-181-118	—
13 mm 	Schere gebogen, längeres Blatt Handgriff Ø 8 mm Scherenblatt 13 mm <i>Scissors curved, longer blade</i> <i>Handle Ø 8 mm</i> <i>Scissor blade 13 mm</i>	—	381-191-315	—	381-191-321
13 mm 	Schere gebogen, gezahnt, längeres Blatt Handgriff Ø 8 mm Scherenblatt 13 mm <i>Scissors curved, serrated, longer blade</i> <i>Handle Ø 8 mm</i> <i>Scissor blade 13 mm</i>	—	381-201-315	381-201-318	381-201-321

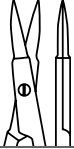
Scheren mit Flachgriff



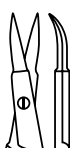

Scissors with Flat Handle

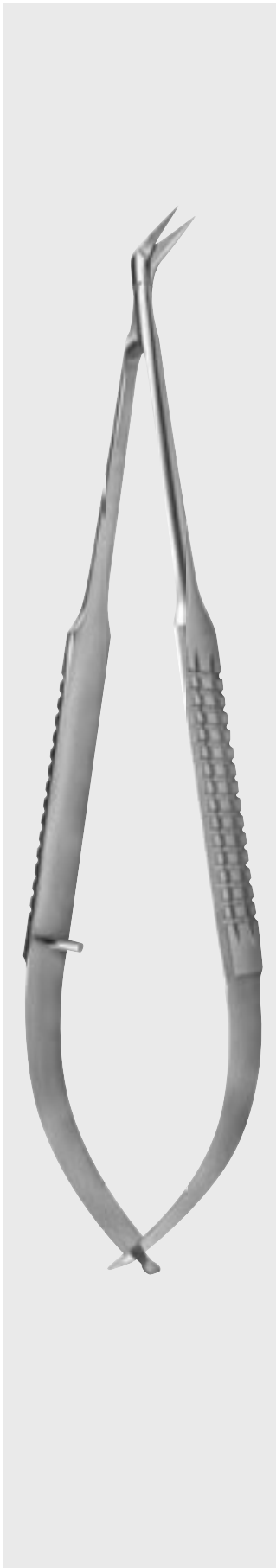

Modell Pattern	Artikel in verschiedenen Längen Article in different lengths	120 mm	150 mm	180 mm	210 mm
10 mm 	Schere gerade, Vannas Handgriff 10 mm Scherenblatt 10 mm <i>Scissors straight, Vannas</i> <i>Handle 10 mm</i> <i>Scissor blade 10 mm</i>	391-011-012	391-011-015	—	—
10 mm 	Schere gerade, spitz Handgriff 10 mm Scherenblatt 10 mm <i>Scissors straight, sharp</i> <i>Handle 10 mm</i> <i>Scissor blade 10 mm</i>	391-021-012	391-021-015	391-021-018	391-021-021
10 mm 	Venen-Schneide, gerade (Biemer) Handgriff 10 mm Scherenblatt 10 mm <i>Veins Scissors, straight (Biemer)</i> <i>Handle 10 mm</i> <i>Scissor blade 10 mm</i>	391-031-012	—	—	—
14 mm 	Schere gerade, spitz Handgriff 10 mm Scherenblatt 14 mm <i>Scissors straight, sharp</i> <i>Handle 10 mm</i> <i>Scissor blade 14 mm</i>	—	391-041-415	391-041-418	391-041-421
10 mm 	Schere gebogen, Vannas Handgriff 10 mm Scherenblatt 10 mm <i>Scissors curved, Vannas</i> <i>Handle 10 mm</i> <i>Scissor blade 10 mm</i>	391-051-012	391-051-015	—	—
10 mm 	Schere gebogen, spitz Handgriff 10 mm Scherenblatt 10 mm <i>Scissors curved, sharp</i> <i>Handle 10 mm</i> <i>Scissor blade 10 mm</i>	391-061-012	391-061-015	391-061-018	391-061-021
14 mm 	Schere gebogen, spitz Handgriff 10 mm Scherenblatt 14 mm <i>Scissors curved, sharp</i> <i>Handle 10 mm</i> <i>Scissor blade 14 mm</i>	—	391-071-415	391-071-418	391-071-421

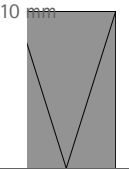
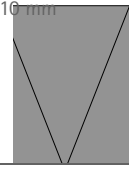
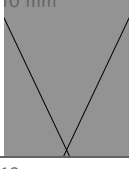
Scheren abgewinkelt mit Flachgriff, gedrehter Schluß Scissors angled with Flat Handle, streamlined

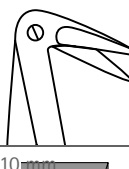
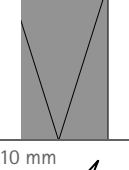
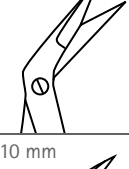
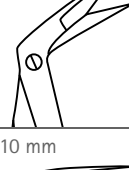
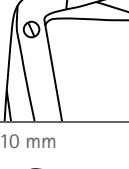

Modell Pattern	Artikel in verschiedenen Längen Article in different lengths	150 mm	180 mm	210 mm
	Schere mit Kugel, spitz, abgewinkelt 25° Handgriff 10 mm, Scherenblatt 10 mm Scissors with ball, sharp, angled 25° Handle 10 mm, scissor blade 10 mm	—	391-091-018	—
	Schere mit Kugel, spitz, abgewinkelt 45° Handgriff 10 mm, Scherenblatt 10 mm Scissors with ball, sharp, angled 45° Handle 10 mm, scissor sblade 10 mm	—	391-101-018	—
	Schere mit Kugel, spitz, abgewinkelt 60° Handgriff 10 mm, Scherenblatt 10 mm Scissors with ball, sharp, angled 60° Handle 10 mm, scissor blade 10 mm	—	391-111-018	—
	Schere mit Kugel, spitz, abgewinkelt 90° Handgriff 10 mm, Scherenblatt 10 mm Scissors with ball, sharp, angled 90° Handle 10 mm, scissor blade 10 mm	—	391-121-018	—
	Schere mit Kugel, spitz, abgewinkelt 125° Handgriff 10 mm, Scherenblatt 10 mm Scissors with ball, sharp, angled 125° Handle 10 mm, scissor blade 10 mm	—	391-131-018	—
	Schere ohne Kugel, spitz, abgewinkelt 25° Handgriff 10 mm, Scherenblatt 10 mm Scissors without ball, sharp, angled 25° Handle 10 mm, scissor blade 10 mm	—	391-141-018	—
	Schere ohne Kugel, spitz, abgewinkelt 45° Handgriff 10 mm, Scherenblatt 10 mm Scissors without ball, sharp, angled 45° Handle 10 mm, scissor blade 10 mm	—	391-151-018	—
	Schere ohne Kugel, spitz, abgewinkelt 60° Handgriff 10 mm, Scherenblatt 10 mm Scissors without ball, sharp, angled 60° Handle 10 mm, scissor blade 10 mm	—	391-161-018	—
	Schere ohne Kugel, spitz, abgewinkelt 90° Handgriff 10 mm, Scherenblatt 10 mm Scissors without ball, sharp, angled 90° Handle 10 mm, scissor blade 10 mm	—	391-171-018	—
	Schere ohne Kugel, spitz, abgewinkelt 125° Handgriff 10 mm, Scherenblatt 10 mm Scissors without ball, sharp, angled 125° Handle 10 mm, scissor blade 10 mm	—	391-181-018	—

Pinzetten für Mikro-Gefäßklemmen
Forceps for Microvascular Clamps

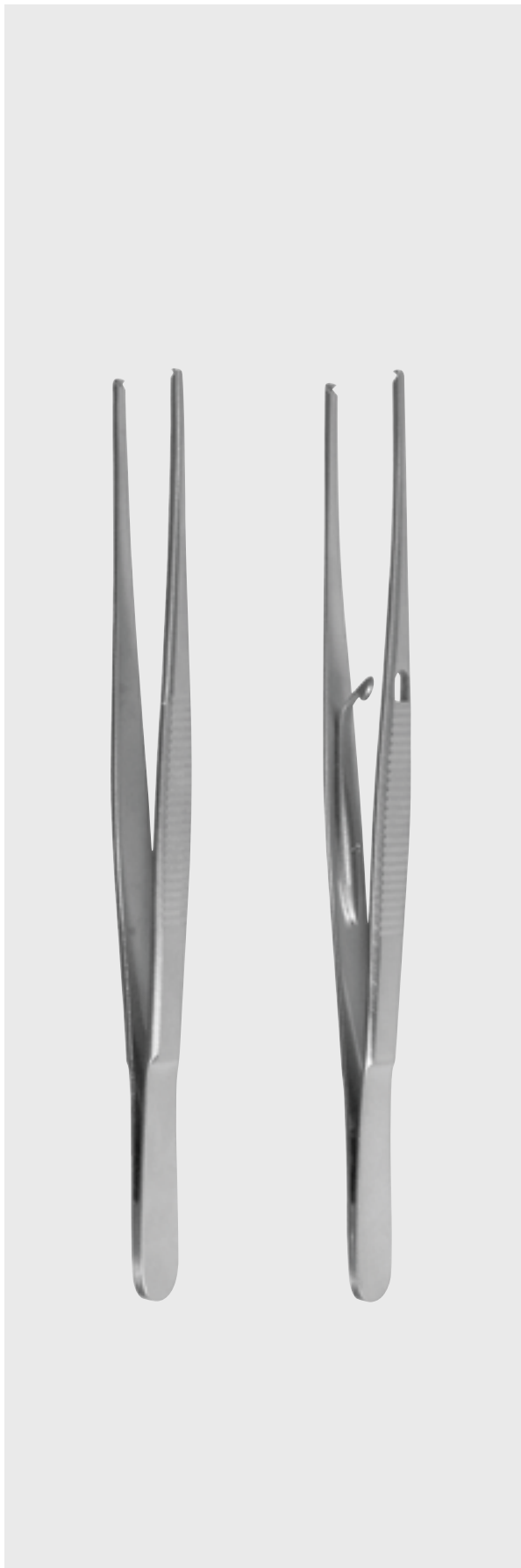

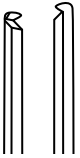
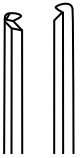
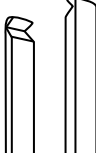
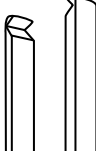
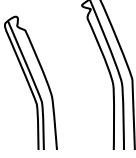
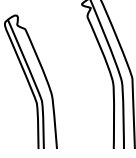















	Artikel Article	140 mm
 Nr. 1 - 2	Anlegepinzette gerade <i>Clamp applying forceps straight</i>	350-011-014
 Nr. 1 - 2	Anlegepinzette gerade mit Sperre <i>Clamp applying forceps straight with lock</i>	350-111-014
 Nr. 3 - 5	Anlegepinzette gerade <i>Clamp applying forceps straight</i>	350-022-214
 Nr. 3 - 5	Anlegepinzette gerade mit Sperre <i>Clamp applying forceps straight with lock</i>	350-122-214
 Nr. 1 - 2	Anlegepinzette, 30° abgewinkelt <i>Clamp applying forceps, 30° angulated</i>	350-031-014
 Nr. 1 - 2	Anlegepinzette, 30° abgewinkelt mit Sperre <i>Clamp applying forceps, 30° angulated with lock</i>	350-131-014

Mikro-Gefäßklemmen

Microvascular Clamps



	Klemme Nr. 1 Clamp No. 1	Klemme Nr. 2 Clamp No. 2	Klemme Nr. 3 Clamp No. 3	Klemme Nr. 4 Clamp No. 4	Klemme Nr. 5 Clamp No. 5
Länge Length	8 mm	11 mm	16 mm	24 mm	35 mm
Gefäß Ø Vessel Ø	0.3 - 1.0 mm	0.6 - 1.4 mm	1.0 - 2.2 mm	1.5 - 3.3 mm	2.0 - 5.0 mm
Einzelklemmen Single Clamps					
Artikelnummer Article Number	351-501-1V1 351-501-1A1	351-501-1V2 351-501-1A2	351-501-1V3 351-501-1A3	351-501-1V4 -	351-501-1V5 -
Doppelklemmen verstellbar Double Clamps Approximator					
Artikelnummer Article Number	351-502-2V1 351-502-2A1	351-502-2V2 351-502-2A2	351-502-2V3 351-502-2A3	351-502-2V4 -	351-502-2V5 -
Doppelklemmen verstellbar mit Rahmen Double Clamps Approximator with frame				-	-
Artikelnummer Article Number	351-503-2V1 351-503-2A1	351-503-2V2 351-503-2A2	351-503-2V3 351-503-2A3		
Doppelklemmen mit Rahmen Double Clamps with frame				-	-
Artikelnummer Article Number	351-504-2V1 351-504-2A1	351-504-2V2 351-504-2A2	351-504-2V3 351-504-2A3		
DC Einzelklemme DC Single Clamp				-	-
Artikelnummer Article Number	351-505-1V1 351-505-1A1	351-505-1V2 351-505-1A2	351-505-1V3 351-505-1A3		

	Klemme Nr. 1 Clamp No. 1	Klemme Nr. 2 Clamp No. 2	Klemme Nr. 3 Clamp No. 3	Klemme Nr. 4 Clamp No. 4	Klemme Nr. 5 Clamp No. 5
Länge Length	8 mm	11 mm	16 mm	24 mm	35 mm
Gefäß Ø Vessel Ø	0.3 - 1.0 mm	0.6 - 1.4 mm	1.0 - 2.2 mm	1.5 - 3.3 mm	2.0 - 5.0 mm
Einzelklemmen Single Clamps					
Artikelnummer Article Number	350-501-1V1 350-501-1A1	350-501-1V2 350-501-1A2	350-501-1V3 350-501-1A3	350-501-1V4 -	350-501-1V5 -
Doppelklemmen verstellbar Double Clamps Approximator					
Artikelnummer Article Number	350-502-2V1 350-502-2A1	350-502-2V2 350-502-2A2	350-502-2V3 350-502-2A3	350-502-2V4 -	350-502-2V5 -
Doppelklemmen verstellbar mit Rahmen Double Clamps Approximator with frame				-	-
Artikelnummer Article Number	350-503-2V1 350-503-2A1	350-503-2V2 350-503-2A2	350-503-2V3 350-503-2A3		
Doppelklemmen mit Rahmen Double Clamps with frame				-	-
Artikelnummer Article Number	350-504-2V1 350-504-2A1	350-504-2V2 350-504-2A2	350-504-2V3 350-504-2A3		
DC Einzelklemme DC Single Clamp				-	-
Artikelnummer Article Number	350-505-1V1 350-505-1A1	350-505-1V2 350-505-1A2	350-505-1V3 350-505-1A3		

Sterilisations-Kassetten

Sterilization Cassettes



Um Ihre Instrumente sicher zu lagern und zu sterilisieren, empfehlen wir Ihnen unsere Kassetten. Sie haben für jede Kassette drei verschiedene Instrumenten-Halterungen zur Auswahl.

For secure storage and optimal sterilisation, we recommend our cassettes. You can choose between three instrument racks.

Modell Pattern	Dose gelocht Box perforated	Größe (Länge x Breite x Höhe) Measurement (length x width x height)
		Außenmaß 65x42 x 8 mm External dimension 65x42x8 mm
Artikelnummer Article Number	129-101-065	

Modell Pattern	Kassette Nr. 1 Cassette No. 1	Größe (Länge x Breite x Höhe) Measurement (length x width x height)
		Außenmaß 220 x 165 x 55 mm Innenmaß 200 x 140 x 45 mm External dimension 220x165x55 mm Internal dimension 200x140x45 mm
Artikelnummer Article Number	380-221-650	
		
Artikelnummer Article Number	380-221-651	380-221-652
		
		380-221-653

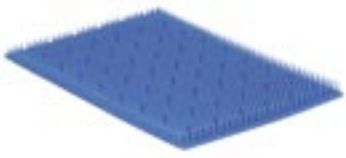

Sterilisations-Kassetten Sterilization Cassettes

Modell Pattern	Kassette Nr. 2 Cassette No. 2	Größe (Länge x Breite x Höhe) Measurement (length x width x height)
		Außenmaß 300 x 220 x 55 mm Innenmaß 280 x 195 x 45 mm External dimension 300 x 220 x 55 mm Internal dimension 280 x 195 x 45 mm
Artikelnummer Article Number	380-302-250	
		
Artikelnummer Article Number	380-302-251	380-302-252
		
Artikelnummer Article Number		380-302-253

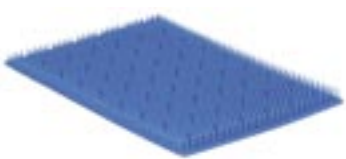
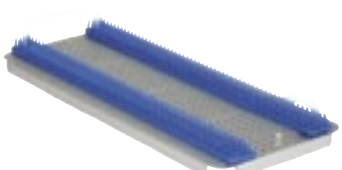
Modell Pattern	Kassette Nr. 3 Cassette No. 3	Größe (Länge x Breite x Höhe) Measurement (length x width x height)
Container Container 380-242-450 Sieb mit Deckel Strainer with lid 380-242-454		Container Außenmaß 300 x 290 x 100 mm Innenmaß 227 x 170 x 60 mm Container External dimension 300 x 290 x 100 mm Internal dimension 227 x 170 x 60 mm
Artikelnummer Article Number	380-242-450	380-242-454
		
Artikelnummer Article Number	380-242-451	380-242-452
		
Artikelnummer Article Number		380-242-453

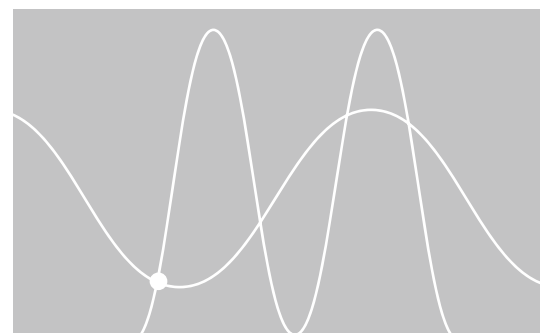

www.micromed.biz



Micromed Medizintechnik GmbH
Eisenbahnstr. 84
D-78573 Wurmlingen

Tel +49 7461 96 48 55 0
Fax +49 7461 96 48 55 95

info@micromed.biz
www.micromed.biz